



# St Aiden's Homeschool

South Africa



Halloween Fun

Colouring, Puzzles & Mazes



Name: \_\_\_\_\_

Date: \_\_\_\_\_

## **PREFACE**

**This book is an eclectic collection of simple puzzles & activities that have been created with my children and put together into book form. Focus is on fun, number recognition and tracing and picture/word association. Clipart primarily from Microsoft Clip Art Collection & Hershey.com, with thanks. Further acknowledgements and credits can be found at the back of this book.**

**We wish you and your families a safe, fun-filled and Happy Halloween and hope to bring you even more activities next year ☺**



Colour the blocks using the key below. ☺

Halloween Activity Book

0	0	0	0	0	0	0	1	0	0	0	0	0	0	0	0
0	0	0	0	0	0	1	1	1	0	0	0	0	4	4	4
0	0	0	0	0	0	1	1	1	0	0	0	0	4	4	4
0	0	0	0	0	1	1	1	1	1	0	0	0	4	4	4
0	0	0	1	1	1	1	1	1	1	1	1	0	0	4	0
0	0	0	0	0	5	3	5	3	5	0	0	0	0	4	0
5	5	0	0	0	5	5	5	5	5	0	0	0	5	4	5
5	1	0	0	0	5	2	2	2	5	0	0	0	1	4	0
0	1	1	0	0	0	5	5	5	0	0	0	1	1	4	0
0	0	1	1	0	1	1	1	1	1	0	1	1	0	4	0
0	0	0	1	1	1	1	1	1	1	1	1	0	0	4	0
0	0	0	0	1	1	1	1	1	1	1	0	0	0	4	0
0	0	0	0	1	1	1	1	1	1	1	0	0	0	4	0
0	0	0	1	1	1	1	1	1	1	1	1	1	0	0	0
0	0	0	0	0	1	0	0	0	1	0	0	0	0	0	0
0	0	0	0	0	1	0	0	0	1	0	0	0	0	0	0
0	0	0	0	1	1	0	0	0	1	1	0	0	0	0	0
0	0	0	1	0	1	0	0	0	1	0	1	0	0	0	0

0=White

1=Black

2=Red

3=Blue

4=Yellow

5=Pink





#### 5 little pumpkins finger play

Five little Pumpkins sitting on a gate  
The first one said "Oh, my it's getting late!"  
The Second one said "There are witches in the air!"  
The Third one said "Well, we don't care!"  
The Forth one said "We will run and run and run!"  
The Fifth one said "We are ready for some fun!"  
Whoooo oooo went the wind  
And out went the light  
and the five little pumpkins rolled out of sight!

#### Variation of song above

Five little witches stirring a Halloween brew  
The first one said "There is nothing to do!"  
The Second one said "Let's go out and have some fun!"  
The Third one said "Halloween has begun!"  
The Forth one said "Let's go out and "trick or treat!"  
The Fifth one said "We will get a lot of candy to eat!"  
Whoooo oooo went the wind  
And out went the light  
and the five little witches flew out of sight!



## 10 little Witches

sung to 10 little indians

1 little, 2 little, 3 little witches,  
4 little, 5 little, 6 little witches,  
7 little, 8 little, 9 little witches,  
10 little witches in the sky!

## 10 little pumpkins

sung to 10 little indians

1 little, 2 little, 3 little pumpkins,  
4 little, 5 little, 6 little pumpkins,  
7 little, 8 little, 9 little pumpkins,  
10 little pumpkins for Halloween!



Finish Writing the Story in your own words. Ask an adult to help you if you like. 😊

As I was walking to the next house I heard footsteps behind me. I stopped. There was nothing there...





Colour in the clown. Punch holes in the circles. Thread yarn or string through the holes. Use as a Halloween mask afterwards.





# Colour the words

bat



cat



hat



rat



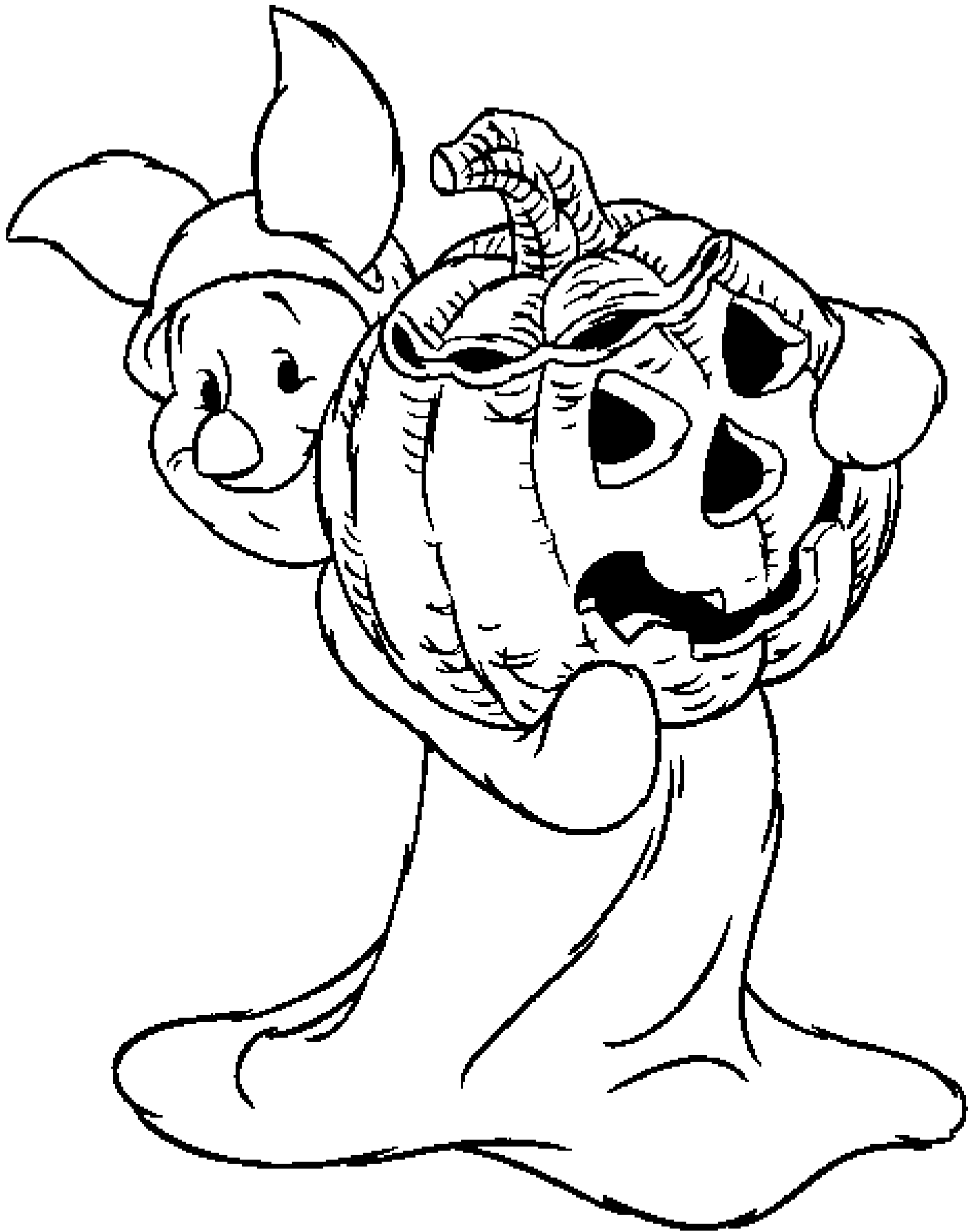



Draw 1 extra tooth on the Jack-o-Lantern. Colour the pumpkin.

Draw 5 witches' hats. Colour the picture.



Colour the picture beautifully.



Draw 6 little pumpkins inside the big pumpkin. Colour them beautifully.

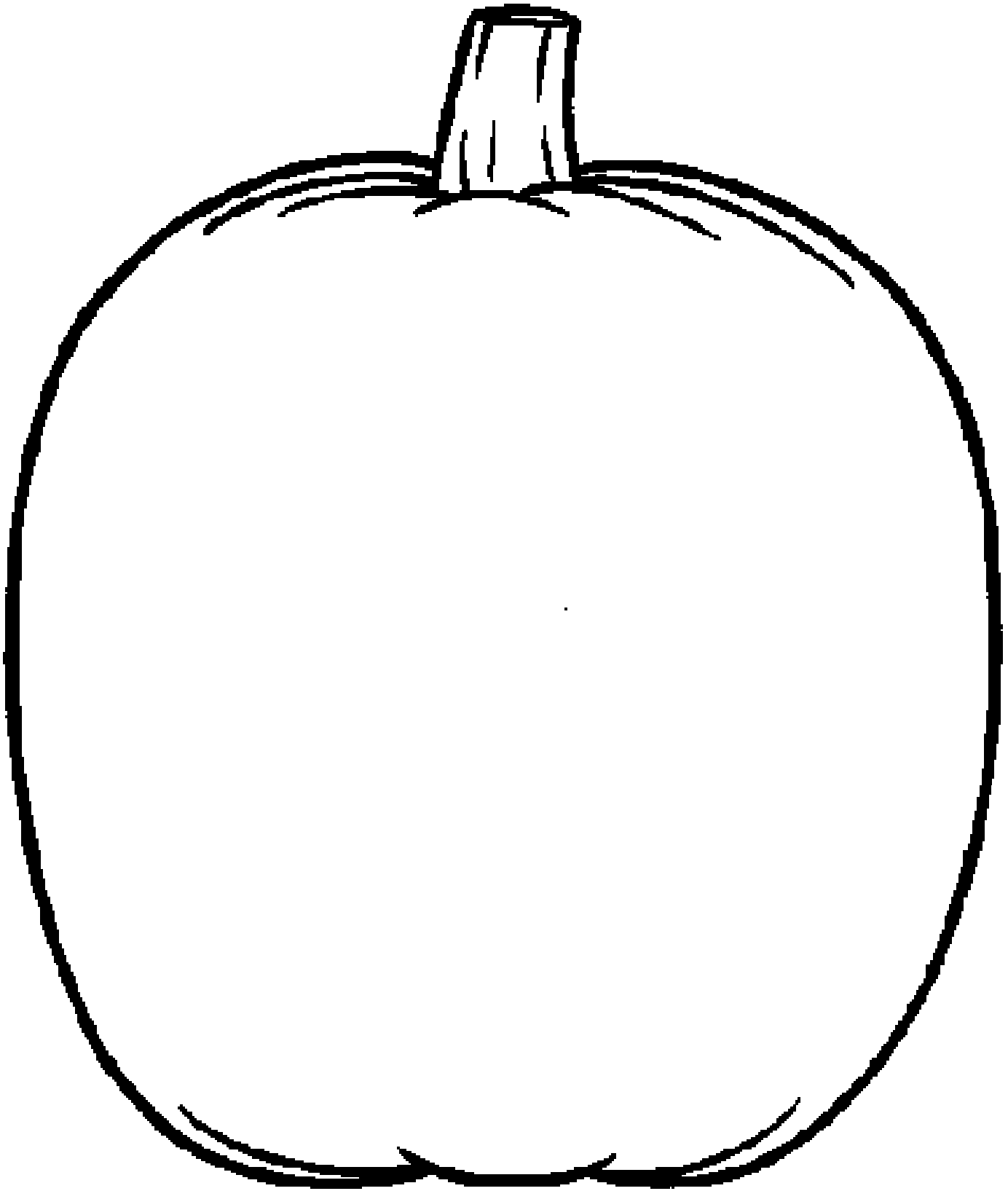

Casper this friendly ghost is looking for his friends. Are you able to draw 7 extra friends for him to play with?.



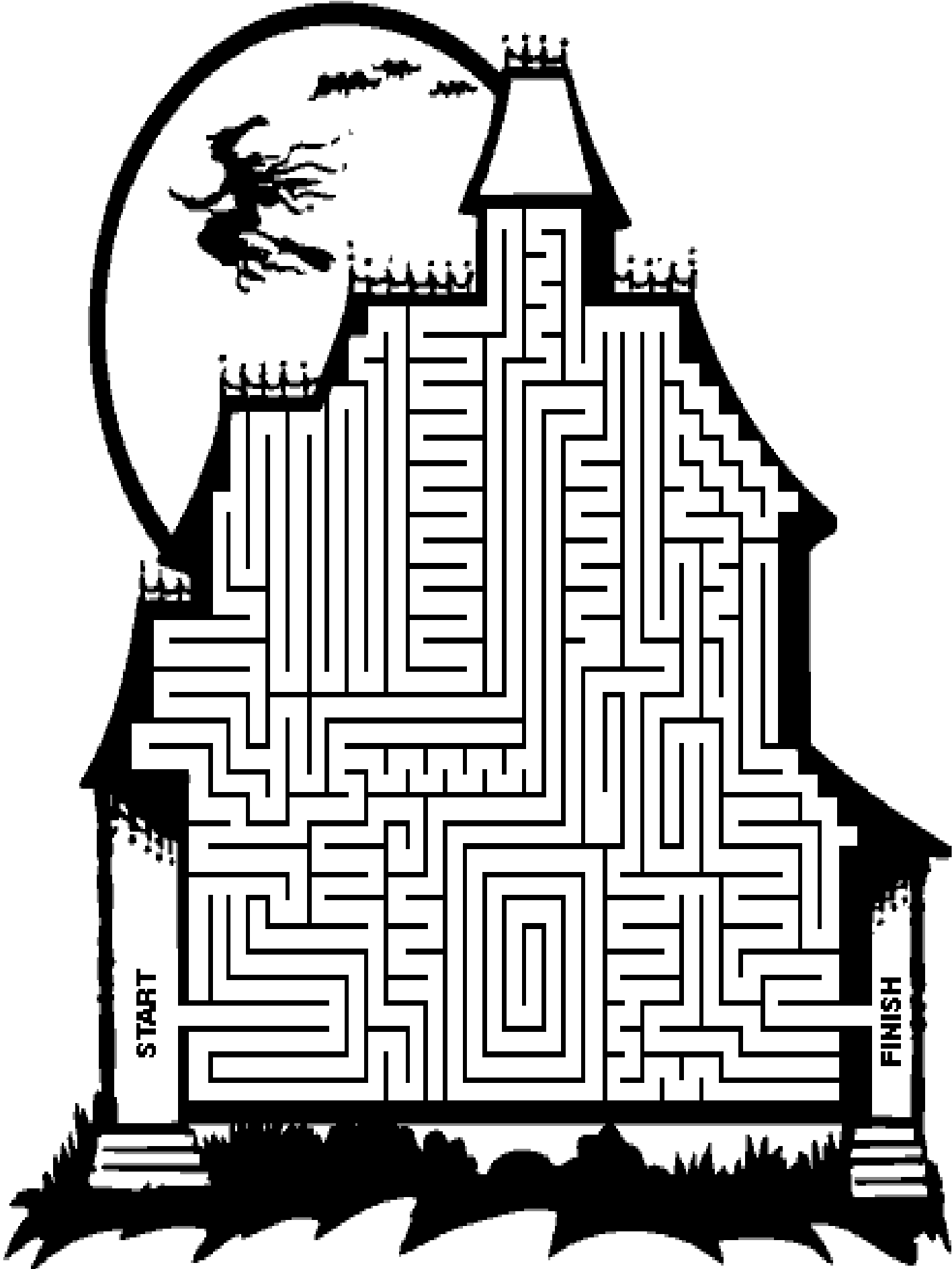



Make a paper broomstick ☺ Please ask an adult to help you with cutting. Remember scissors should ONLY be used under adult supervision ☺

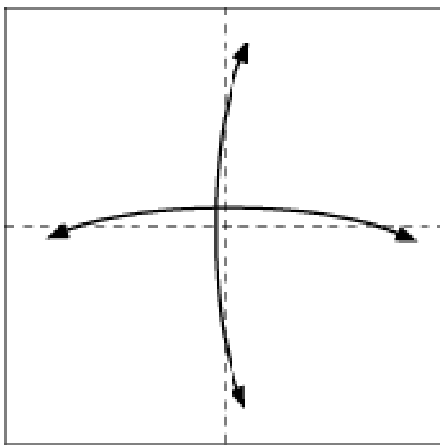

**1** Fold in the dotted lines to make creases and fold back

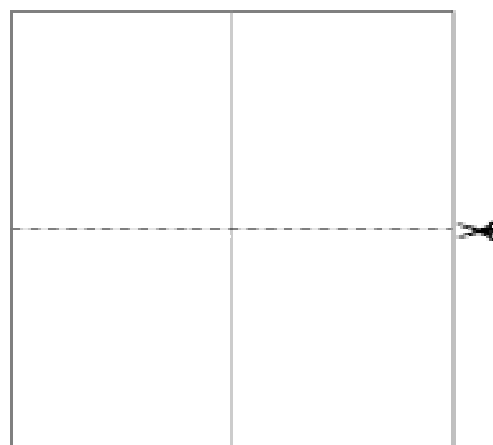

**2** Cut with a pair of scissors

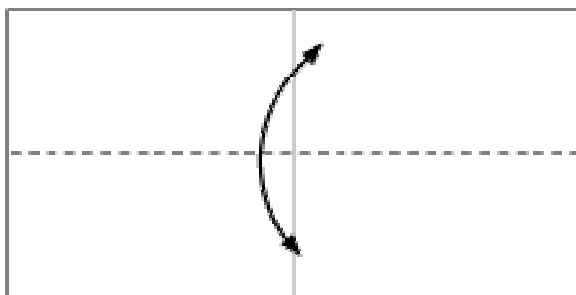

**3** Fold to make a crease and unfold

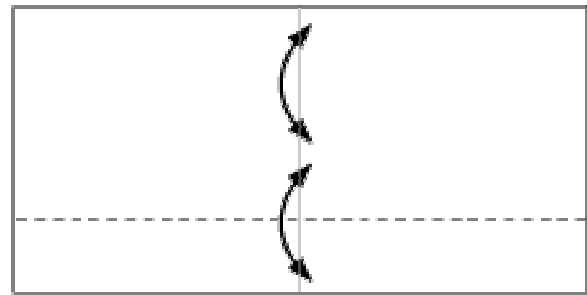

**4** Fold to make a creases and unfold

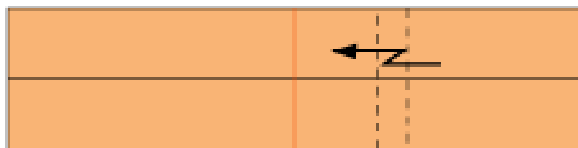

**5** Fold forward in the dotted lines



**6** Fold to make creases and unfold

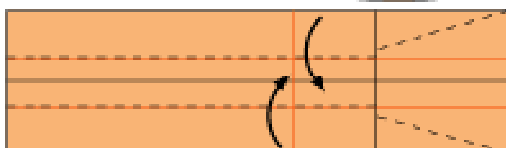

**7** Fold in the dotted lines

**8** Finished

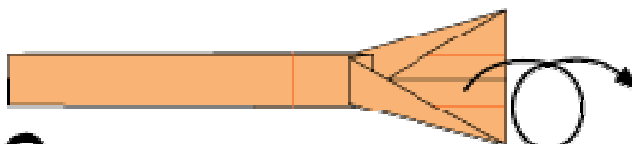
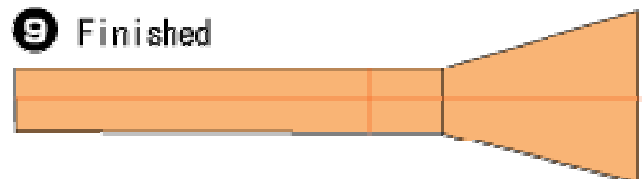

**9** Turn over

# A Broom

Make a paper Dracula ☺ Please ask an adult to help you with cutting. Remember scissors should ONLY be used under adult supervision ☺

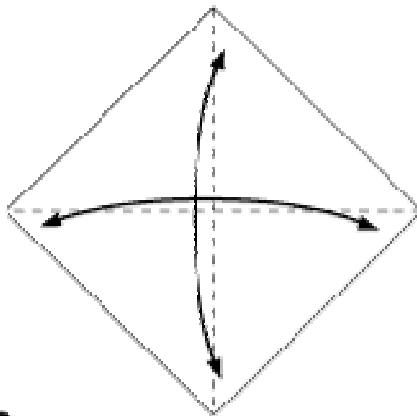

**1** Fold in the dotted lines to make creases and fold back

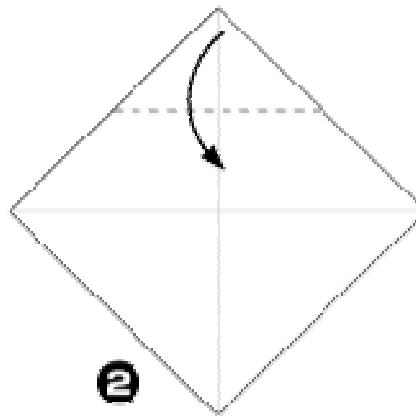

**2** Fold in the dotted line

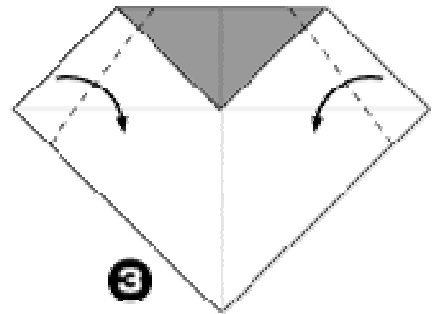

**3** Fold in the dotted line

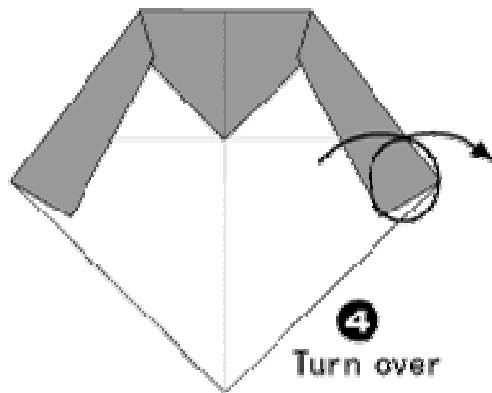

**4** Turn over

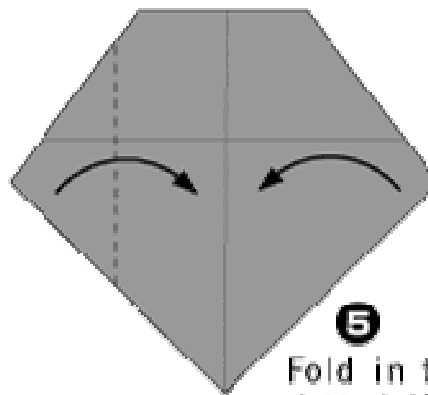

**5** Fold in the dotted lines

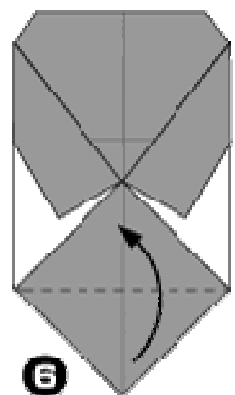

**6** Fold in the dotted line

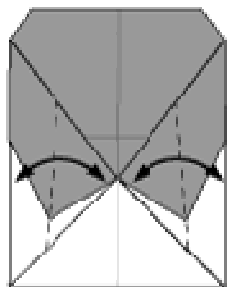

**7** Fold to make creases and unfold

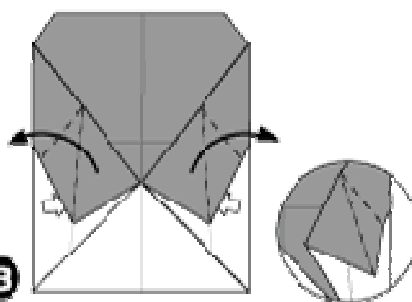

**8** Open the pockets from ☺ and flatten

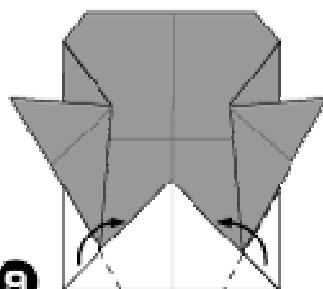

**9** Fold in the dotted lines

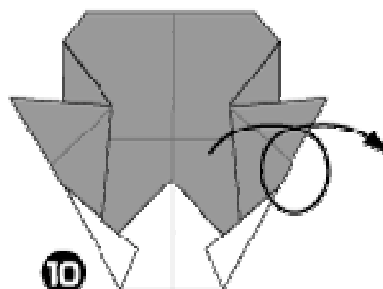

**10** Turn over

**11** Draw a face and finished



# Dracula

Make a paper Jack-O-Lantern. Please ask an adult to help you if you are using scissors or glue. ☺

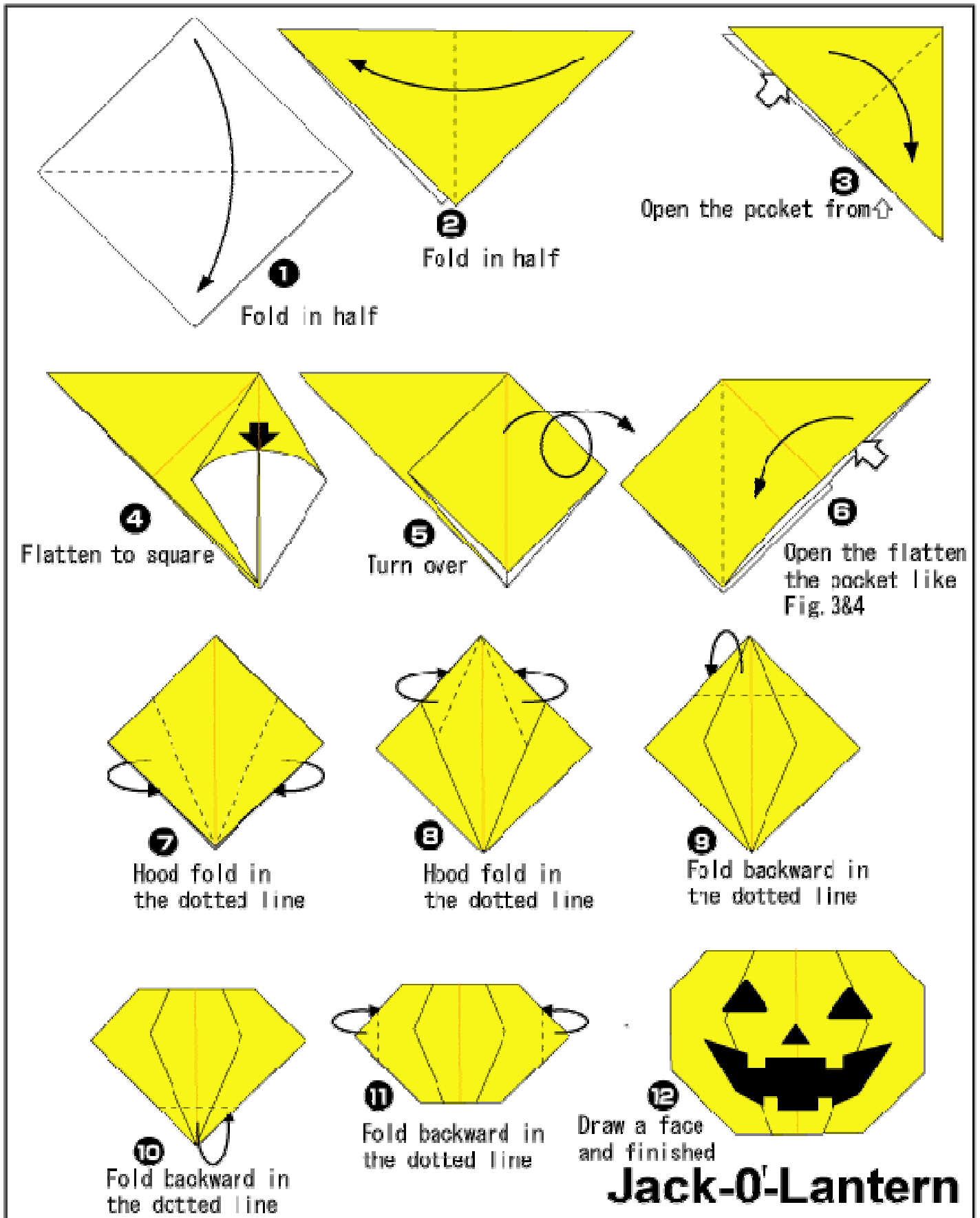

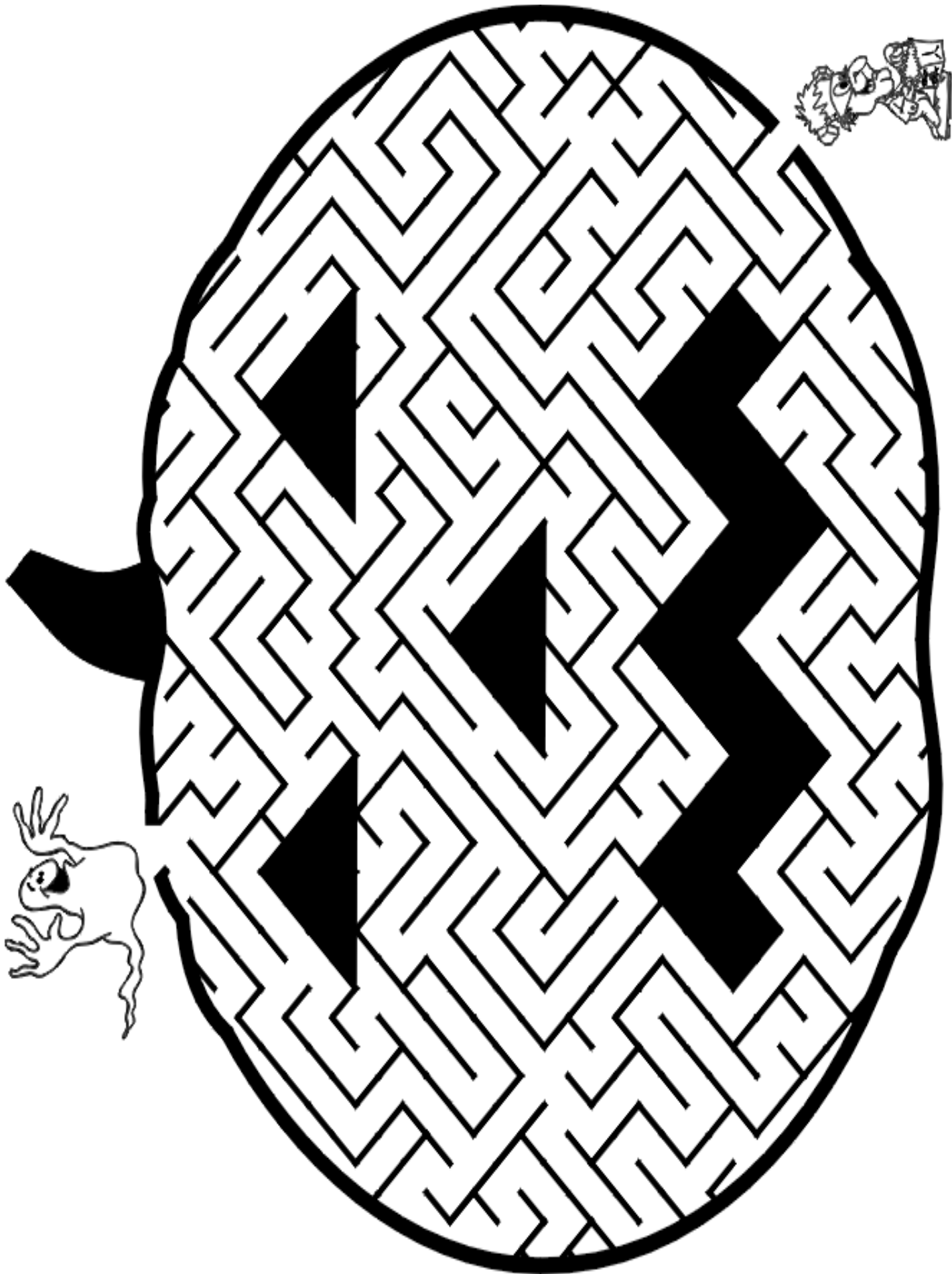

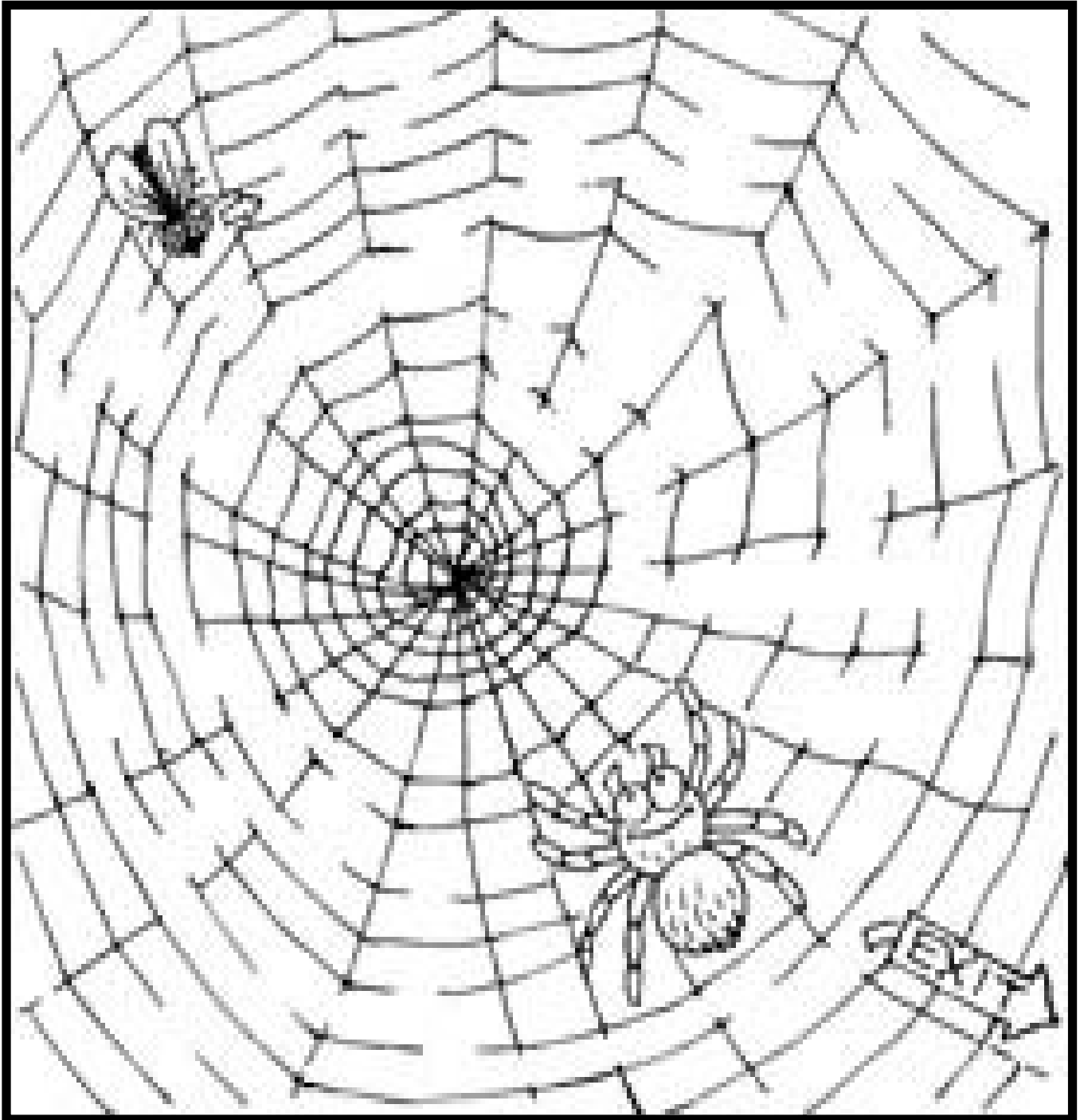

Trace Your Way Through The Maze And Help The Mummy Find the Pyramid 😊

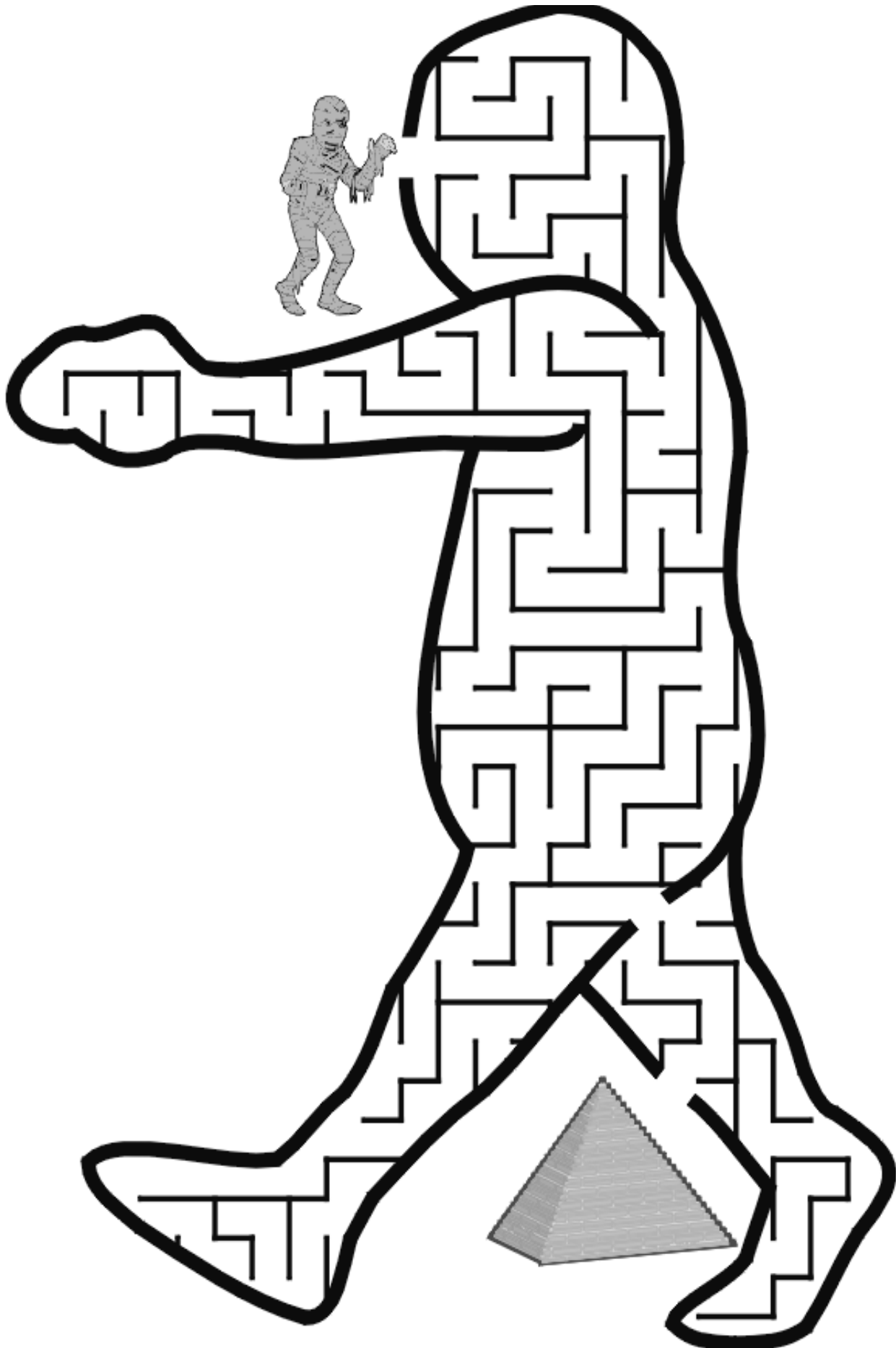

Trace Your Way Through The Maze and help the little witch  
find her barrow of pumpkins 😊

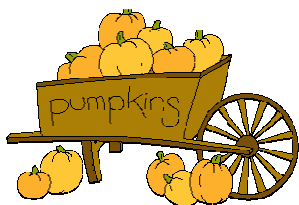
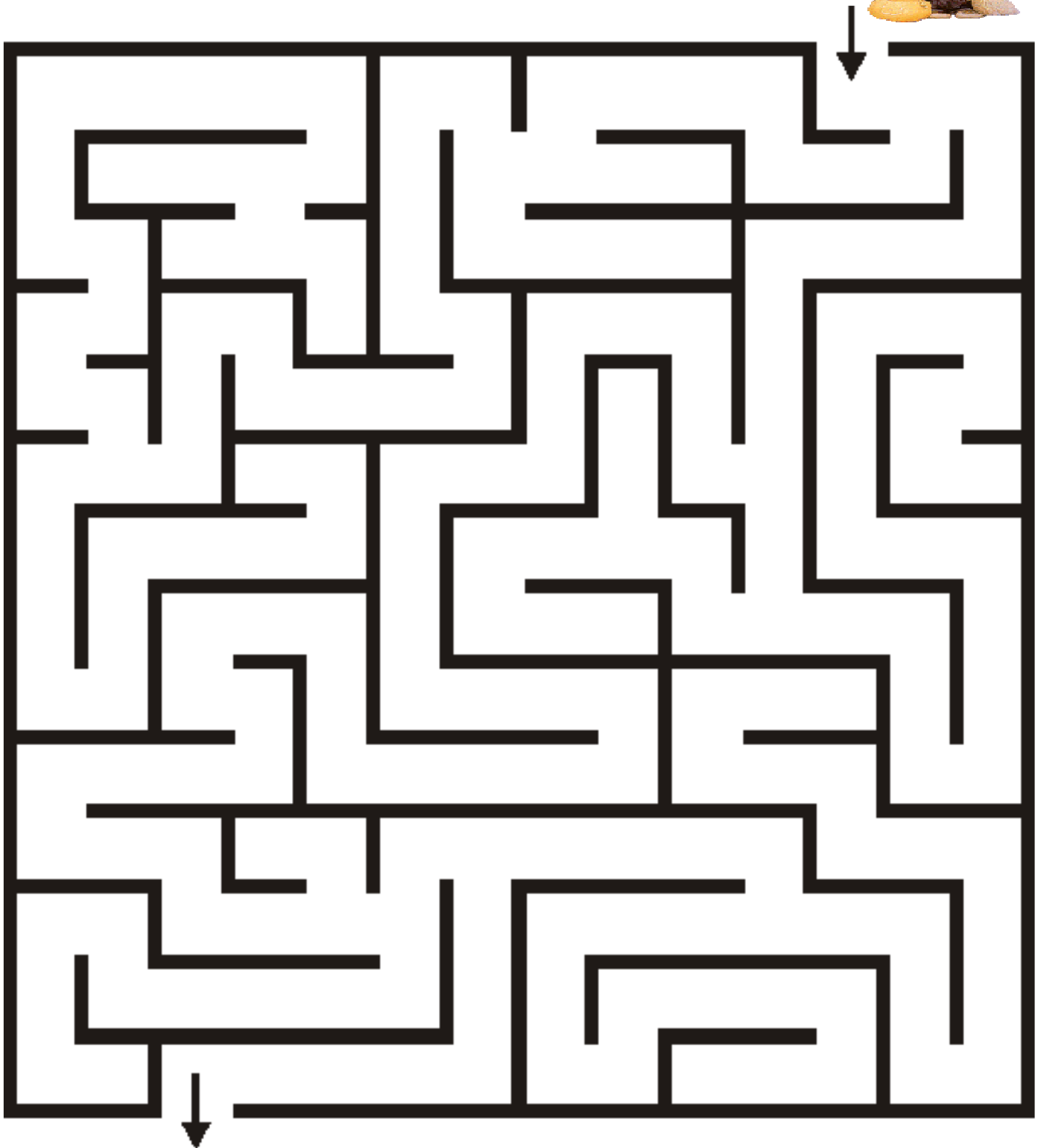

# Halloween Wordsearch

Find and circle all of the words from the word bank. The words can go across, down or diagonally.

p	u	m	p	k	i	n	a	c	b	o	k
t	e	p	o	w	l	s	f	n	a	c	a
a	r	w	p	p	n	x	p	h	i	t	t
g	w	i	o	l	e	a	l	t	c	o	q
h	a	t	c	f	e	l	s	h	a	b	z
o	e	e	n	k	w	m	j	k	u	e	v
s	l	w	q	m	o	o	n	i	l	r	p
t	y	b	o	o	l	r	o	n	d	p	r
f	o	f	r	k	l	d	t	g	r	a	t
l	a	b	t	e	a	n	n	r	o	r	y
y	w	i	t	c	h	s	i	t	n	t	x

pumpkin  
Halloween  
cat

witch  
trick  
hat

bat  
ghost  
cauldron

broomstick  
October  
flu

moon  
boo  
owl





**How many words can you make from the words  
Jack-o-Lantern?**

A series of 30 horizontal lines for writing, arranged in three columns of ten. Each line in a column is grouped by a dashed line in the middle, providing a guide for letter height.





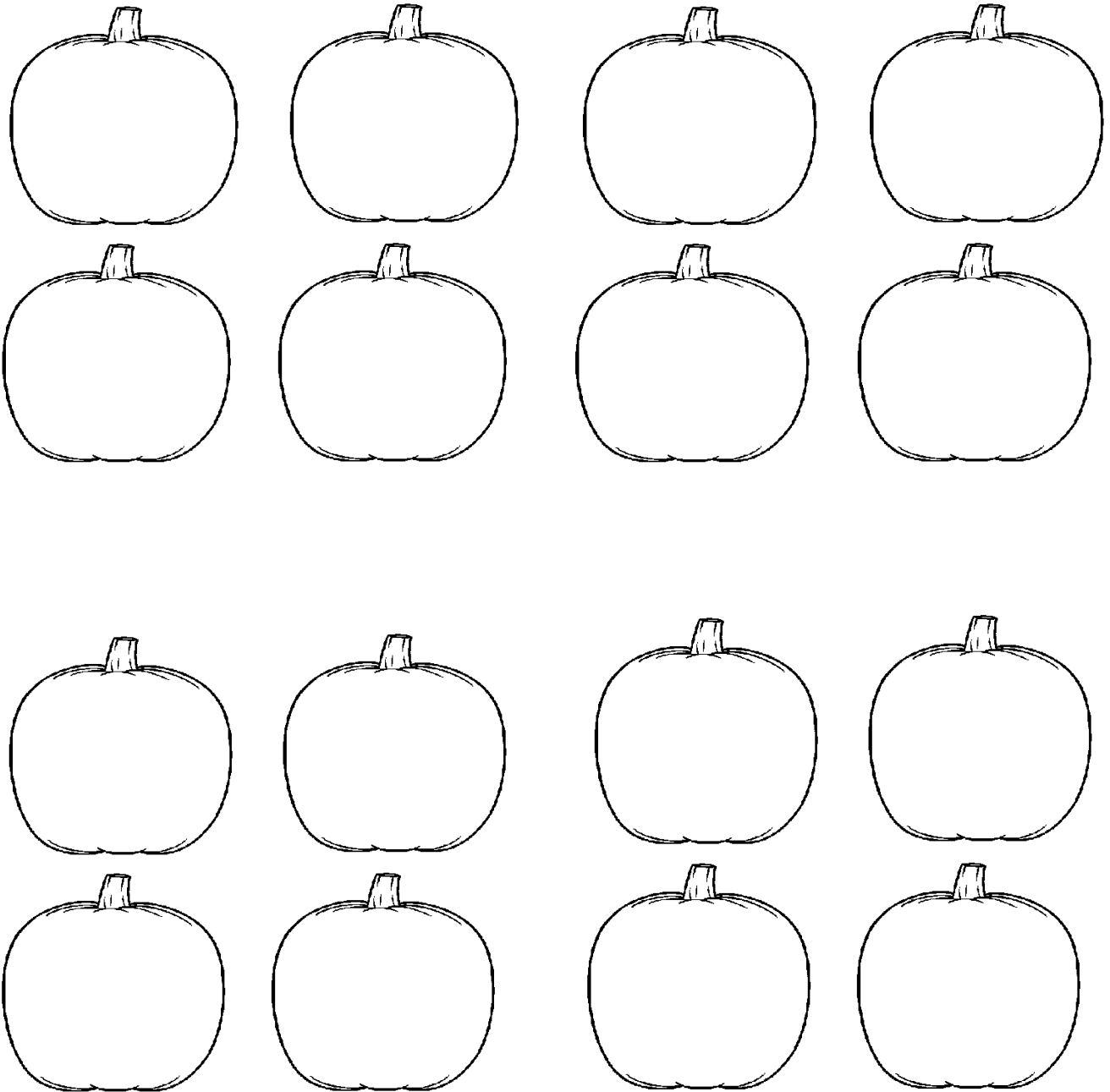

Are you able to circle 5 differences between the pictures on this page?  
Answers at the end of the book.



Following Directions  
Colour 4 Pumpkins orange;  
Colour 1 pumpkins yellow;  
Colour 2 pumpkins green;  
Colour 3 pumpkin red.



Write the correct number in the box. ☺

Colour the squares.

□ □ □ □ □ □ □ □ □ □	□ □ □ □ □ □ □ □ □ □
Colour five squares red.	Colour three squares yellow.

□ □ □ □ □ □ □ □ □ □	□ □ □ □ □ □ □ □ □ □
Colour six squares green.	Colour three squares red.

□ □ □ □ □ □ □ □ □ □	□ □ □ □ □ □ □ □ □ □
Colour four squares yellow.	Colour six squares blue.

□ □ □ □ □ □ □ □ □ □	□ □ □ □ □ □ □ □ □ □
Colour six squares orange.	Colour five squares pink.

□ □ □ □ □ □ □ □ □ □	□ □ □ □ □ □ □ □ □ □
Colour four squares brown.	Colour six squares black.

□ □ □ □ □ □ □ □ □ □	□ □ □ □ □ □ □ □ □ □
Colour ten squares light blue.	Colour eight squares purple.

□ □ □ □ □ □ □ □ □ □	□ □ □ □ □ □ □ □ □ □
Colour six squares red.	Colour eight squares green.

□ □ □ □ □ □ □ □ □ □	□ □ □ □ □ □ □ □ □ □
Colour four square yellow.	Colour two squares brown.

□ □ □ □ □ □ □ □ □ □	□ □ □ □ □ □ □ □ □ □
Colour ten squares green.	Colour six squares yellow.

□ □ □ □ □ □ □ □ □ □	□ □ □ □ □ □ □ □ □ □
Colour three squares orange.	Colour five squares blue.

□ □ □ □ □ □ □ □ □ □	□ □ □ □ □ □ □ □ □ □
Colour eight squares pink.	Colour ten squares grey.





Read the number and colour that many squares in your favourite colours.

9												
---	--	--	--	--	--	--	--	--	--	--	--	--

10												
----	--	--	--	--	--	--	--	--	--	--	--	--

5												
---	--	--	--	--	--	--	--	--	--	--	--	--

1												
---	--	--	--	--	--	--	--	--	--	--	--	--

2												
---	--	--	--	--	--	--	--	--	--	--	--	--

6												
---	--	--	--	--	--	--	--	--	--	--	--	--

11												
----	--	--	--	--	--	--	--	--	--	--	--	--

5												
---	--	--	--	--	--	--	--	--	--	--	--	--

4												
---	--	--	--	--	--	--	--	--	--	--	--	--

7												
---	--	--	--	--	--	--	--	--	--	--	--	--

8												
---	--	--	--	--	--	--	--	--	--	--	--	--

Draw a line from each picture to the correct number.

	<p>two</p> 
	<p>eight</p> 
	<p>six</p> 
	<p>seven</p> 
	<p>five</p> 

Colour the group that has less.

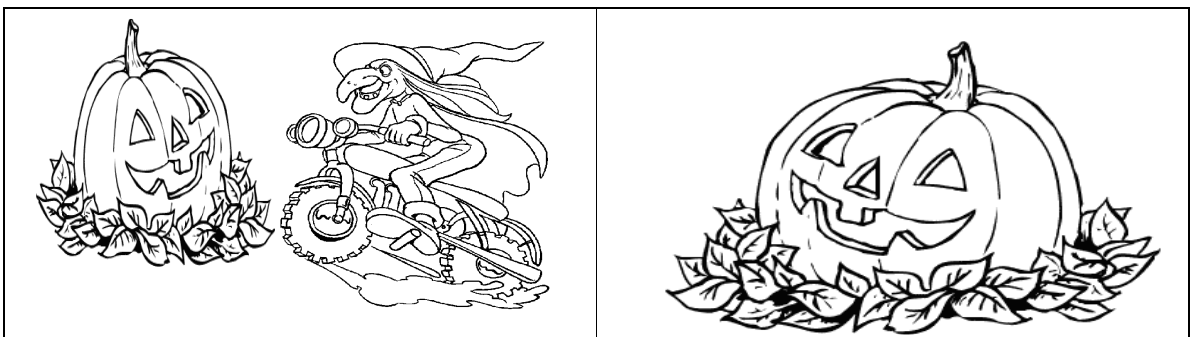
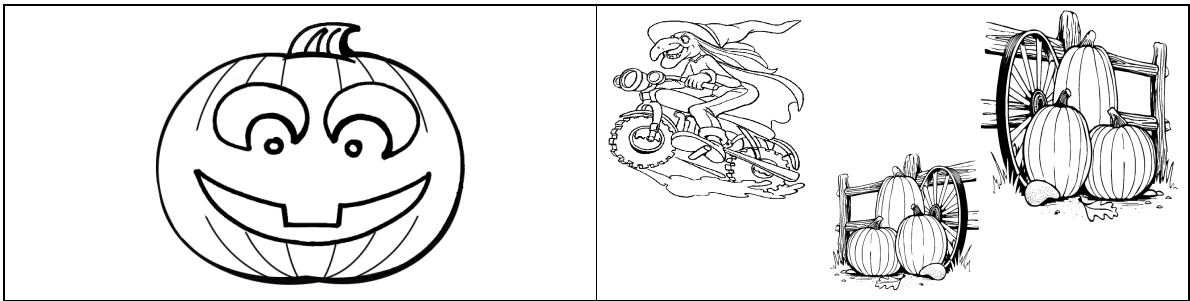
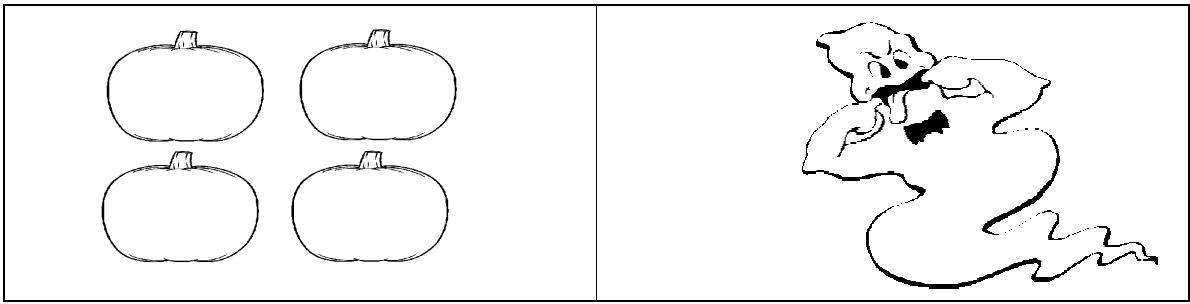



Circle the number that shows how many. ☺



2    4    6    8    10



1    3    5    7    9



3    6    9    8    5



2    5    7    3    9    10

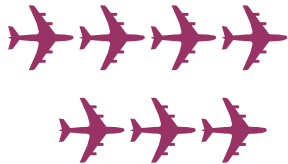

7    9    10    8    2



5    1    6    2    9    3



0    4    6    7    9



3    2    9    8    5    4



We would love to hear your comments on this workbook. If you have a moment please email your comments and suggestions to [feedback@staidenshomeschool.com](mailto:feedback@staidenshomeschool.com)

Other Volumes In Our Series Of Workbooks

AFRICA  
ALPHABET, VOWELS & CONSONANTS  
ANIMALS  
COLOURS, SHAPES, PUZZLES  
DOLCH WORDS  
GEOGRAPHY  
HISTORY  
NATURE  
NUMBERS  
PHONICS  
READING  
WORD FAMILIES  
WRITING

This unit is provided on a **NON-PROFIT** basis and in certain circumstances it is provided free of charge or at extremely low cost covering printing and production costs borne entirely by the author with no subsidy, donation or educational grants whatsoever in South Africa or internationally. It may ONLY be sold onward by St Aiden's Homeschool, South Africa, and/or by its duly authorised representatives, for personal and Homeschool/classroom use in the interests of furthering home education in Africa and internationally. This unit may NOT be sold on under any circumstances by any unauthorised person or persons/individuals, companies/organisations or educational institutions, nor may it or any portion thereof be uploaded to any website locally or internationally. Nor may it be amended, altered, appended to, edited, and may only be used in its entirety and original format without addition amendment or omission. Thank you for respecting international copyright laws.

These units have been compiled together with and by my daughters Savannah and Clarissa, who have had enormous fun doing "dictionary work" and then sourcing appropriate graphics. A variety of clipart resources have been used, most notably Microsoft Clipart Collections, Barry's Clip Art, FG-A, Wikipedia, Wiki-Know, [www.keltawebconcepts.com.au](http://www.keltawebconcepts.com.au) and Free Classroom Clipart. Copyright free images were also sourced through Google. Clipart more recently sourced via <http://www.designedtoat.com> & <http://free-clipart.net> who have an amazing selection of really fun and friendly images.

Donnette E Davis –Revised October 2008  
© 2008 St Aiden's Homeschool, Republic of South Africa  
Post Office Box 13720  
Cascades  
3202  
KwaZulu-Natal  
Republic of South Africa

Answers to Spot the Difference: 2 bats to the right of the ghost; 2 bats to the left of the ghost; 3 ghosts; black cat; 4 little pumpkins in the front of the picture

Filename: Halloween Activity Book3  
Directory: C:\Documents and Settings\DONNETTE DAVIS\My Documents\OUR BOOKS\Halloween  
Template: C:\Documents and Settings\DONNETTE DAVIS\Application Data\Microsoft\Templates\Normal.dot  
Title: Halloween Activity  
Subject: Halloween Activity  
Author: DONNETTE DAVIS  
Keywords: Halloween Numbers & Counting Activity  
Comments: Halloween Activity , includes word/picture recognition and other activities, colouring, mazes, wordsearch  
Creation Date: 10/18/2008 10:51:00 AM  
Change Number: 7  
Last Saved On: 10/18/2008 12:47:00 PM  
Last Saved By: DONNETTE DAVIS  
Total Editing Time: 116 Minutes  
Last Printed On: 10/18/2008 12:47:00 PM  
As of Last Complete Printing  
Number of Pages: 34  
Number of Words: 1,243 (approx.)  
Number of Characters: 7,091 (approx.)